



# AGM-12-100

Valve-regulated lead-acid battery



# GENERAL PURPOSE SERIES

## Characteristics

Nominal voltage	12V (6 cells per unit)	
Nominal capacity at 20 hours rate/10.8V (25°C)	100Ah	
Capacity (25°C)	10 Hours rate/10.8V	93Ah
	5 Hours rate/10.8V	85.5Ah
Terminal type	T16	
Torque	12.3±2.5N.m	
Approx. internal resistance (25°C)	4.5mΩ	
Dimensions	Length	330±2mm (12.99inch)
	Width	171±2mm (6.65inch)
	Height	214±2mm (8.43inch)
	Total height (T14)	220±2mm (8.66inch)
Design Life (stand-by)	JIS at 25°C	10 years
	Eurobat at 20°C	10/12 years
Weight	28.50kg (65.04lbs)±3%	
Nominal operating temperature	25°C±3 (77±5°F)	
Operating temperature range	Discharge	-15°C~50°C (5°F~122°F)
	Charge	-10°C~50°C (14°F~122°F)
	Storage	-20°C~50°C (-4°F~122°F)
Float charging voltage at 25°C	13.5V~13.8V	
Cyclic charging voltage at 25°C	14.5V~15.0V	
Temperature compensation	Float charge	-18 mV/°C/Block
	Cycle charge	-30 mV/°C/Block
Max. charging current (A)	30A	
Max. discharge current for 5 seconds	800A	
Self discharge rate (25°C)	≤3%/month	
Battery container ABS UL94-HB	V-0 optional	

## Overview

General Purpose series batteries are de-signed with state-of-the-art AGM (absorbent glass mat) technology, high-performance plates and electrolyte. With excellent value and characteristics, this range is suitable for all general purpose applications.

## Dimensions & Terminal Type (mm)

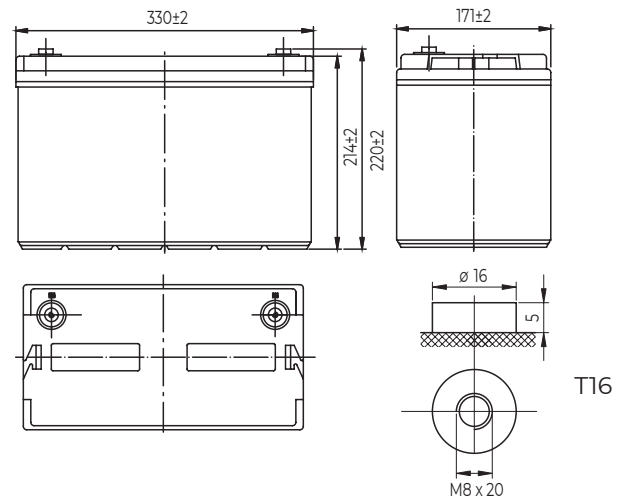

## Construction

Component	Positive Plate	Negative plate	Container	Separator	Electrolyte	Safety valve	Terminal
Raw material	Lead dioxide	Lead	ABS (V-0 opt.)	AGM	Sulfuric Acid	Rubber	Copper

## Constant current discharge characteristics at 25°C

(Ampere/battery)

F.V/Time	10min	15min	30min	60min	2h	3h	4h	5h	8h	10h	20h
9.60V	218	168	101	61.8	36.5	26.3	21.0	18.0	12.3	10.2	5.40
9.90V	211	164	98.5	60.9	36.3	26.2	20.9	17.8	12.3	10.2	5.38
10.2V	203	158	95.5	59.3	36.0	26.0	20.7	17.7	12.2	10.1	5.37
10.5V	194	153	93.2	57.5	35.5	25.8	20.6	17.6	12.1	10.1	5.34
10.8V	183	144	89.7	55.6	34.6	25.0	20.0	17.1	11.7	10.0	5.30

## Constant power discharge characteristics at 25°C

(Watts/battery)

F.V/Time	10min	15min	30min	60min	2h	3h	4h	5h	8h	10h	20h
9.60V	2354	1845	1128	705	423	309	247	212	147	122	64.7
9.90V	2284	1800	1105	694	421	308	246	211	146	121	64.6
10.2V	2190	1734	1071	676	417	306	244	209	145	121	64.4
10.5V	2095	1675	1045	655	411	303	242	208	144	120	64.0
10.8V	1978	1586	1007	634	400	294	235	202	139	119	63.6

The above characteristics represent average values and can be obtained within three charge and discharge cycles. The batteries must be fully charged before testing. The data in this document is subject to change without notice and become contractual only after written confirmation. Please contact Conexpro for the latest available version.

### Discharge characteristics (25°C)

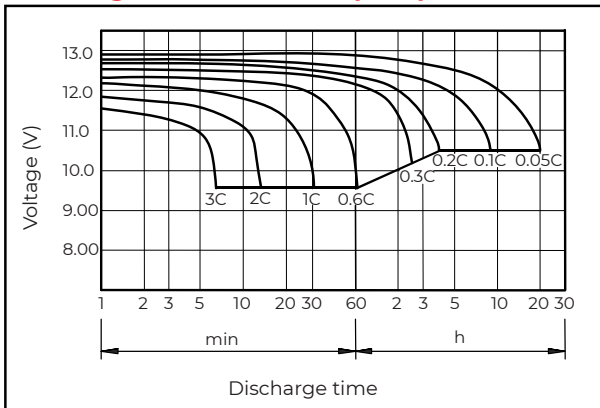

### Charging characteristics (25°C)

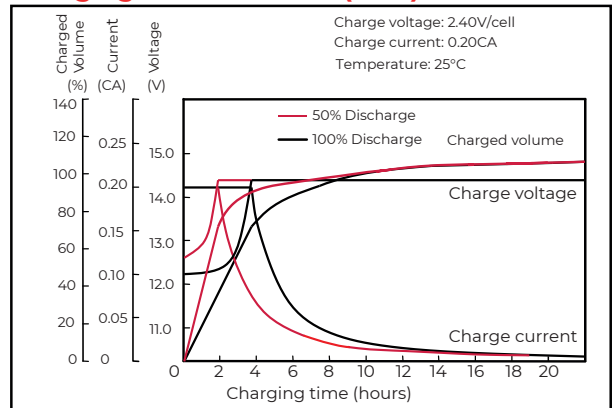

### Temperature effects on capacity

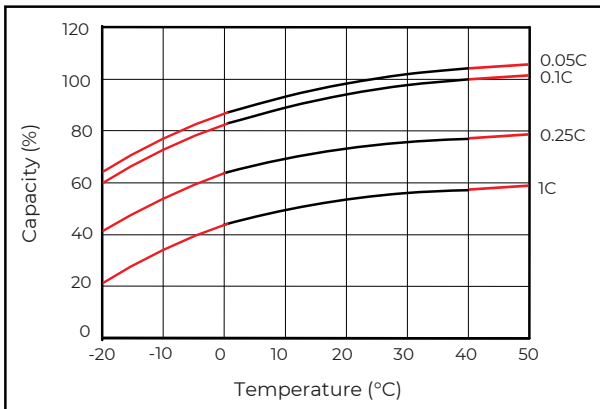

### Self-discharge characteristics

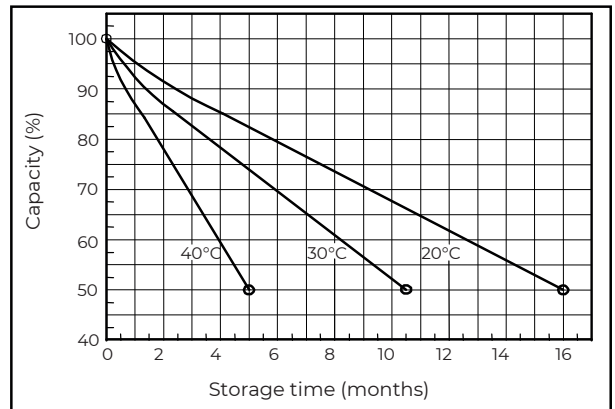

### Floating life on temperature

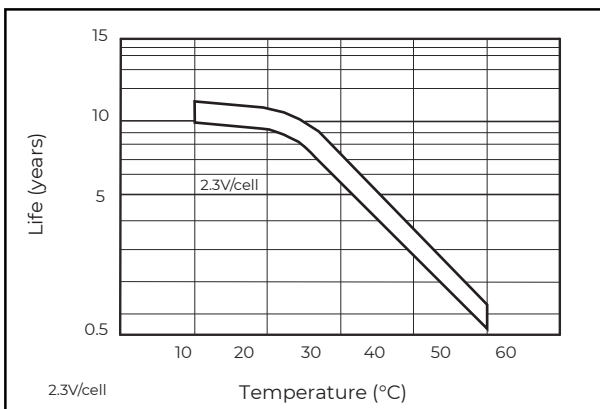

### Cycle life on D.O.D (25°C)

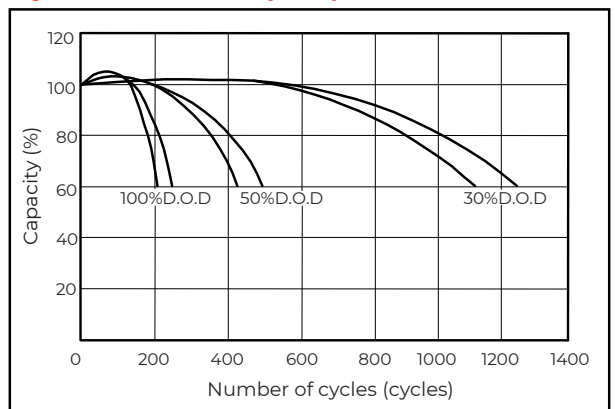

### Relationship for OCV and capacity (25°C)

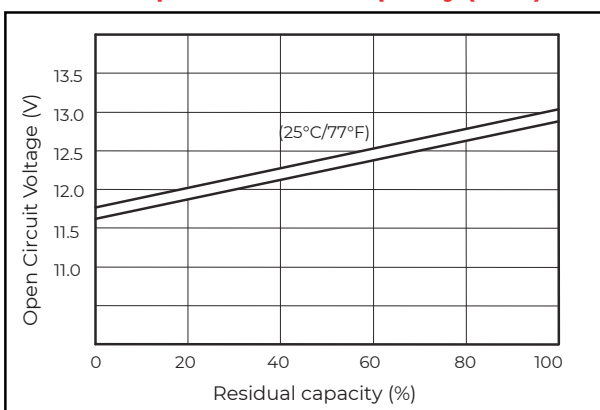

### Charging voltage VS temperature

