



AGM-12-55

Valve-regulated lead-acid battery



GENERAL PURPOSE SERIES

Characteristics

Nominal voltage	12V (6 cells per unit)	
Nominal capacity at 10 hours rate/10.8V (25°C)	55Ah	
Capacity (25°C)	20 Hours rate/10.8V	58.4Ah
	5 Hours rate/10.8V	47Ah
Terminal type	T14	
Torque	5.1±0.6N.m	
Approx. internal resistance (25°C)	6.5mΩ	
Dimensions	Length	230±2mm (9.06inch)
	Width	138±2mm (5.43inch)
	Height	211±2mm (8.31inch)
	Total height (T14)	215±2mm (8.46inch)
Design Life (stand-by)	JIS at 25°C	10 years
	Eurobat at 20°C	10/12 years
Weight	17.30kg (38.10lbs)±3%	
Nominal operating temperature	25°C±3 (77±5°F)	
Operating temperature range	Discharge	-15°C~50°C (5°F~122°F)
	Charge	-10°C~50°C (14°F~122°F)
	Storage	-20°C~50°C (-4°F~122°F)
Float charging voltage at 25°C	13.5V~13.8V	
Cyclic charging voltage at 25°C	14.5V~15.0V	
Temperature compensation	Float charge	-18 mV/°C/Block
	Cycle charge	-30 mV/°C/Block
Max. charging current (A)	16.5A	
Max. discharge current for 5 seconds	550A	
Self discharge rate (25°C)	≤3%/month	
Battery container ABS UL94-HB	V-0 optional	

Overview

General Purpose series batteries are de-signed with state-of-the-art AGM (absorbent glass mat) technology, high-performance plates and electrolyte. With excellent value and characteristics, this range is suitable for all general purpose applications.

Dimensions & Terminal Type (mm)

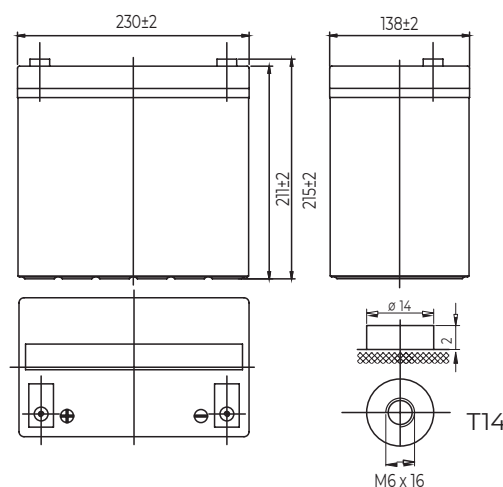

Construction

Component	Positive Plate	Negative plate	Container	Separator	Electrolyte	Safety valve	Terminal
Raw material	Lead dioxide	Lead	ABS (V-0 opt.)	AGM	Sulfuric Acid	Rubber	Copper

Constant current discharge characteristics at 25°C

(Ampere/battery)

F.V/Time	10min	15min	30min	60min	2h	3h	4h	5h	8h	10h	20h
9.60V	120	92.4	55.3	34.0	20.1	14.5	11.6	9.87	6.79	5.60	2.97
9.90V	116	90.2	54.2	33.5	20.0	14.4	11.5	9.82	6.75	5.59	2.96
10.2V	112	86.9	52.5	32.6	19.8	14.3	11.4	9.75	6.70	5.57	2.95
10.5V	107	83.9	51.2	31.6	19.5	14.2	11.3	9.68	6.66	5.54	2.94
10.8V	101	79.5	49.4	30.6	19.0	13.8	11.0	9.39	6.46	5.50	2.92

Constant power discharge characteristics at 25°C

(Watts/battery)

F.V/Time	10min	15min	30min	60min	2h	3h	4h	5h	8h	10h	20h
9.60V	1295	1015	620	387	233	170	136	117	80.6	66.9	35.6
9.90V	1256	990	608	382	231	169	135	116	80.2	66.7	35.5
10.2V	1204	954	589	372	229	168	134	115	79.6	66.5	35.4
10.5V	1152	921	575	360	226	167	133	114	79.1	66.1	35.2
10.8V	1088	873	554	349	220	162	129	111	76.7	65.7	35.0

The above characteristics represent average values and can be obtained within three charge and discharge cycles. The batteries must be fully charged before testing. The data in this document is subject to change without notice and become contractual only after written confirmation. Please contact Conexpro for the latest available version.

Discharge characteristics (25°C)

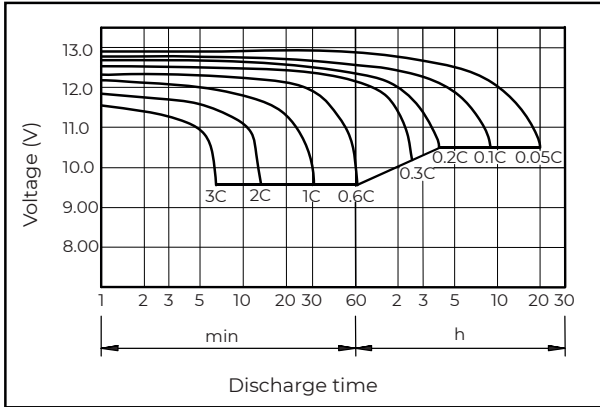

Charging characteristics (25°C)

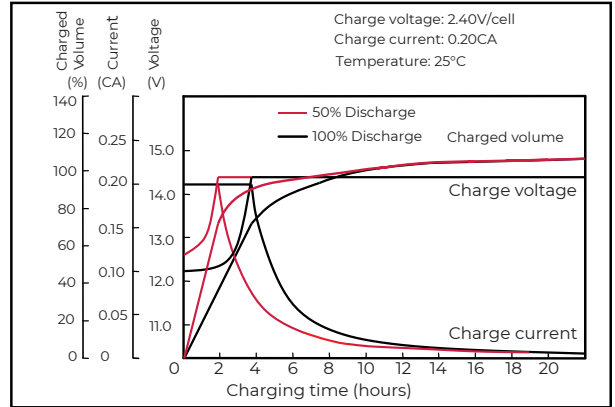

Temperature effects on capacity

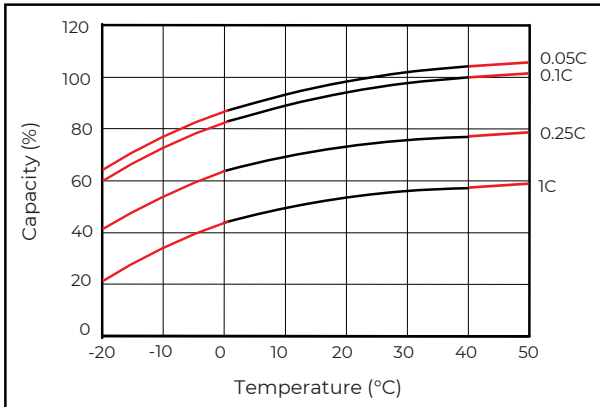

Self-discharge characteristics

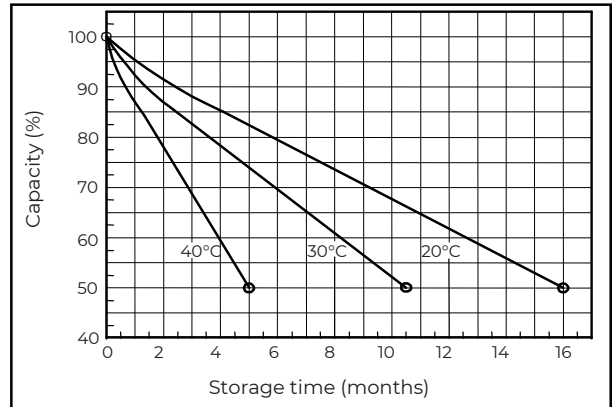

Floating life on temperature

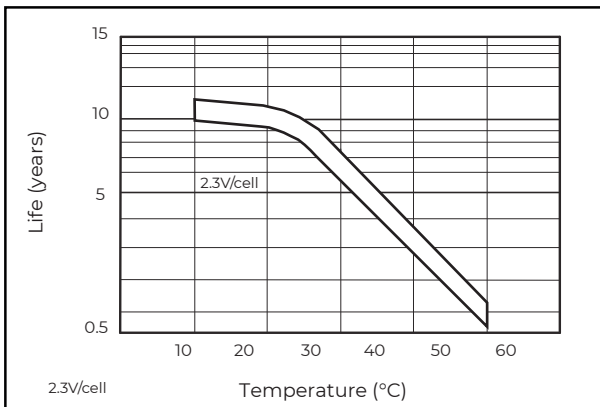

Cycle life on D.O.D (25°C)

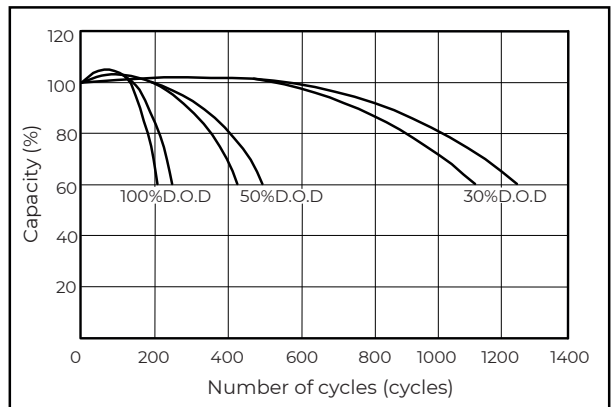

Relationship for OCV and capacity (25°C)

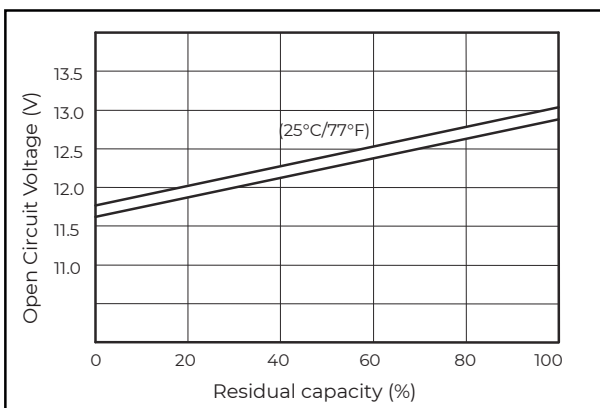

Charging voltage VS temperature

