



AGM-12-9

Valve-regulated lead-acid battery



GENERAL PURPOSE SERIES

Characteristics

Nominal voltage	12V (6 cell per unit)	
Nominal capacity at 20 hours rate/10.5V (25°C)	9Ah	
Capacity (25°C)	10 Hours rate/10.5V	8.4Ah
	5 Hours rate/10.5V	7.7Ah
Terminal type	T1/T2	
Torque	N/A	
Approx. internal resistance (25°C)	20.0 mΩ	
Dimensions	Length	151±1.5mm (5.94inch)
	Width	65±1mm (2.56inch)
	Height	94±1mm (3.70inch)
	Total height	100±1mm (3.94inch)
Design Life (stand-by)	JIS at 25°C	5 years
	Eurobat at 20°C	3-5 years
Weight	2.50kg (4.85lbs)±4%	
Nominal operating temperature	25±3°C (77°F±5)	
Operating temperature range	Discharge	-15°C~50°C (5°F~122°F)
	Charge	-10°C~50°C (14°F~122°F)
	Storage	-20°C~50°C (-4°F~122°F)
Float charging voltage at 25°C	13.6V~13.8V	
Cyclic charging voltage at 25°C	14.5V~15.0V	
Temperature compensation	Float charge	-18 mV/°C/Block
	Cycle charge	-30 mV/°C/Block
Max. charging current (A)	2.7A	
Max. discharge current for 5 seconds	135A	
Self discharge rate (25°C)	≤3%/month	
Battery container ABS UL94-HB	V-0 optional	

Overview

General Purpose series batteries are de-signed with state-of-the-art AGM (absorbent glass mat) technology, high-performance plates and electrolyte. With excellent value and characteristics, this range is suitable for all general purpose applications.

Dimensions & Terminal Type (mm)

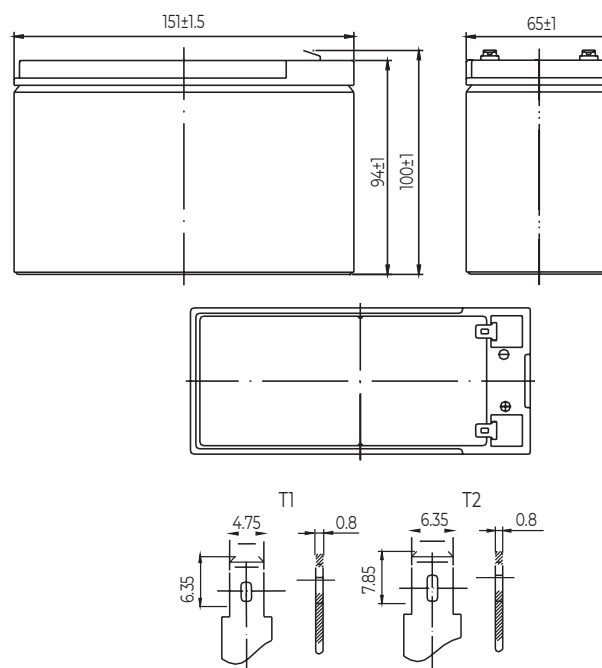

Construction

Component	Positive Plate	Negative plate	Container	Separator	Electrolyte	Safety valve	Terminal
Raw material	Lead dioxide	Lead	ABS (V-0 opt.)	AGM	Sulfuric Acid	Rubber	Copper

Constant current discharge characteristics at 25°C

(Ampere/battery)

F.V/Time	5min	10min	15min	30min	60min	2hr	3hr	4hr	5hr	10hr	20hr
9.60V	34.4	21.8	17.0	9.59	5.90	3.22	2.23	1.85	1.57	0.85	0.46
9.90V	33.3	21.1	16.6	9.39	5.81	3.21	2.22	1.83	1.56	0.85	0.45
10.2V	32.0	20.3	16.0	9.11	5.66	3.18	2.20	1.82	1.55	0.84	0.45
10.5V	30.6	19.4	15.4	8.89	5.55	3.13	2.19	1.81	1.54	0.84	0.45
10.8V	28.9	18.3	14.6	8.56	5.38	3.05	2.12	1.75	1.49	0.82	0.44

Constant power discharge characteristics at 25°C

(Watts/battery)

F.V/Time	5min	10min	15min	30min	60min	2hr	3hr	4hr	5hr	10hr	20hr
9.60V	384	246	194	110	68.3	37.7	26.5	22.0	18.7	10.2	5.48
9.90V	372	238	189	108	67.2	37.5	26.3	21.8	18.6	10.2	5.46
10.2V	357	228	182	104	65.5	37.2	26.2	21.7	18.5	10.1	5.43
10.5V	341	219	176	102	64.2	36.6	26.0	21.5	18.4	10.1	5.40
10.8V	322	206	167	98.1	62.3	35.7	25.2	20.9	17.8	9.87	5.29

The above characteristics represent average values and can be obtained within three charge and discharge cycles. The batteries must be fully charged before testing. The data in this document is subject to change without notice and become contractual only after written confirmation. Please contact Conexpro for the latest available version.

Discharge characteristics (25°C)

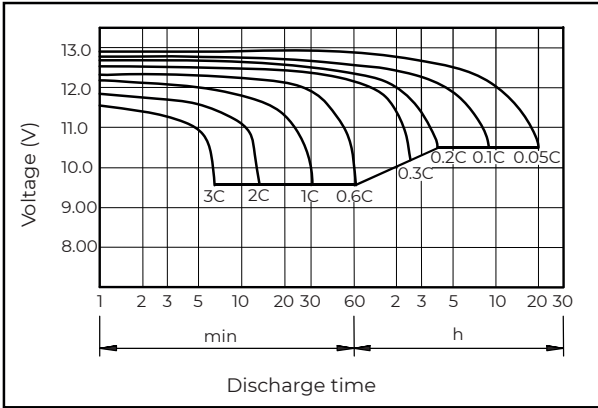

Charging characteristics (25°C)

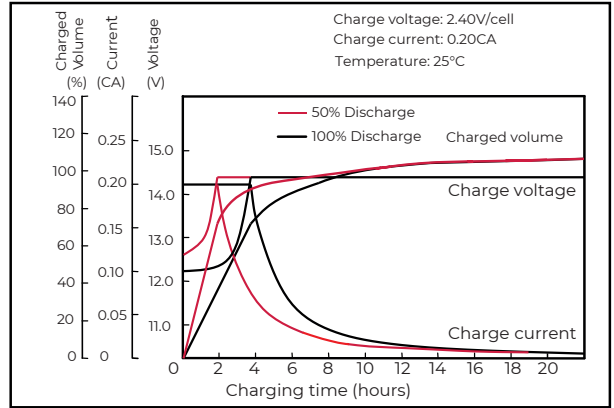

Temperature effects on capacity

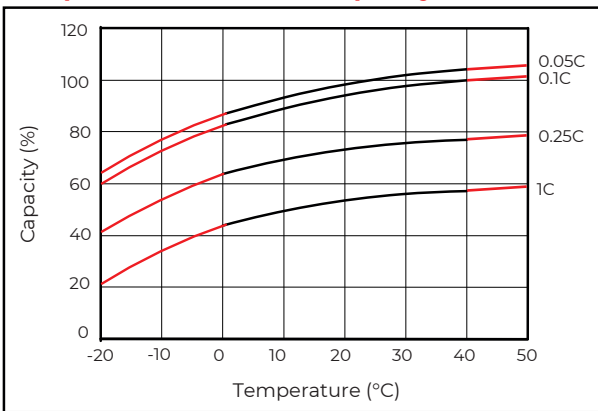

Self-discharge characteristics

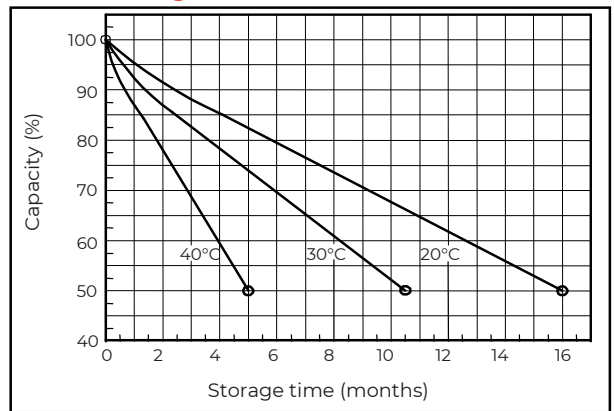

Floating life on temperature

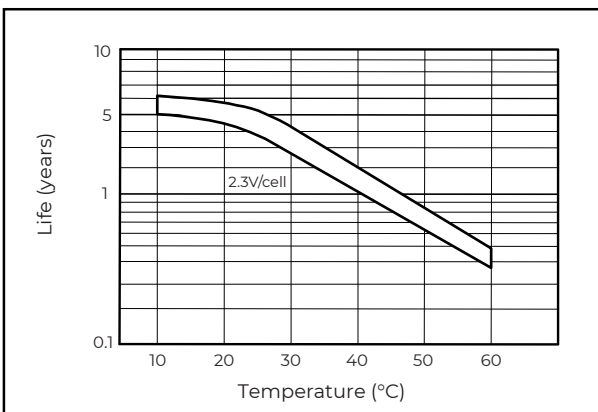

Cycle life on D.O.D (25°C)

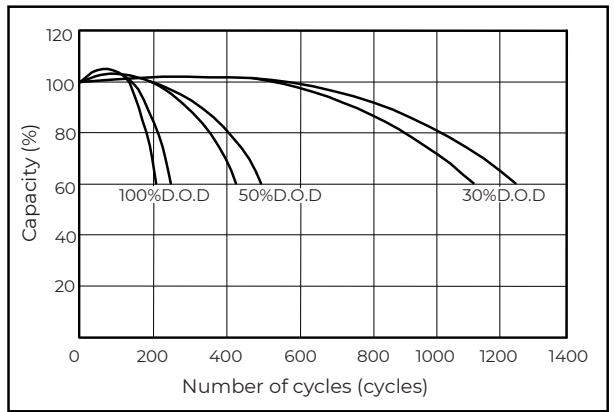

Relationship for OCV and capacity (25°C)

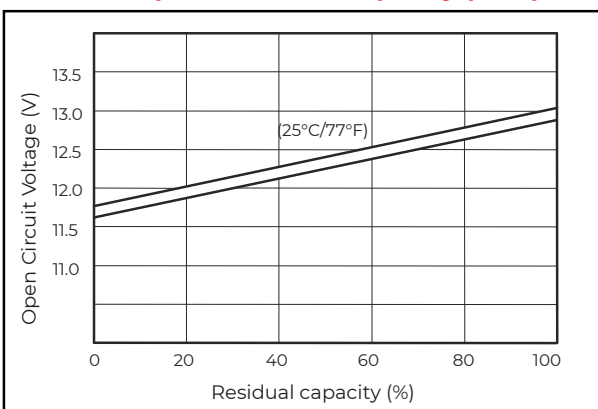

Charging voltage VS temperature

